

Article number: 20608022

Description: E+G Ball transfer unit
GN 509.1-22-SNI

Measures

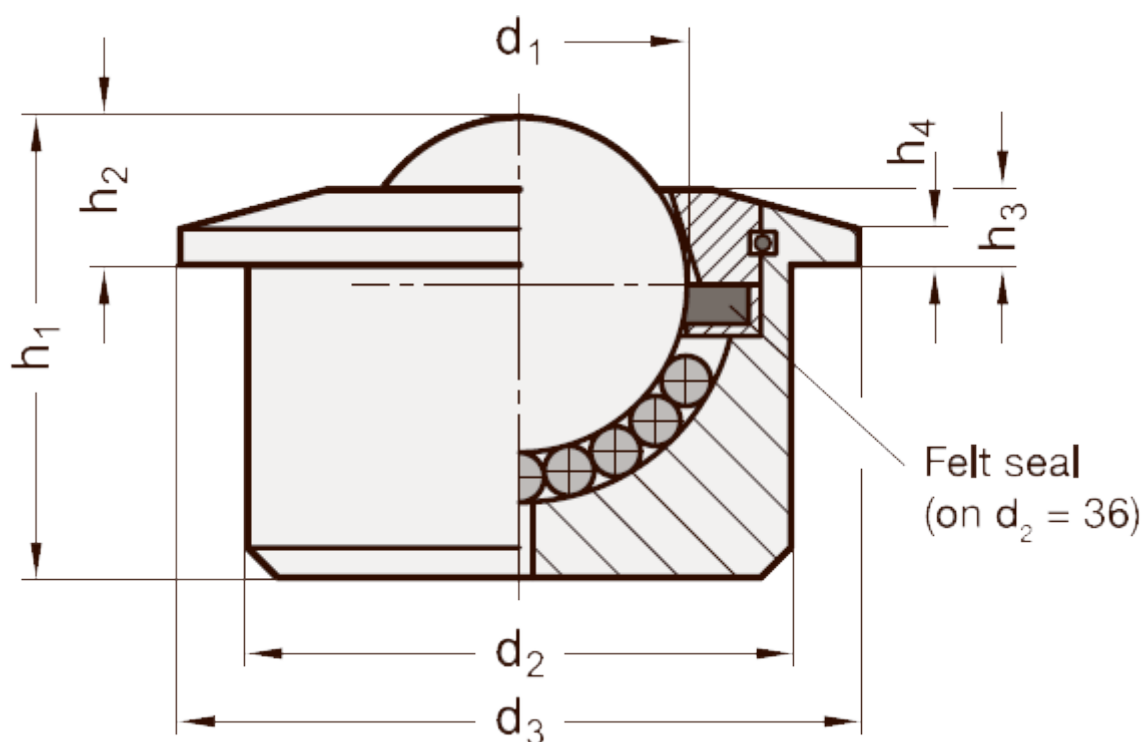

d_1	= 22.2	Size	= 22
$d_2 \pm 0.08$	= 36	Weight in (g)	= 180
d_3	= 45		
$h_1 \pm 0.3$	= 30.5		
$h_2 \pm 0.3$	= 9.8		
$h_3 \pm 0.3$	= 5		
h_4	= 2.4		
Max load (N)	= 1000		